

B DUTCH Linear Light Slim Matt White (BD11.0900001) / Matt Black (BD11.0900003) - 1200 mm - Opbouw INSTALLATIEHANDLEIDING

NL
For ENG
See Other Side

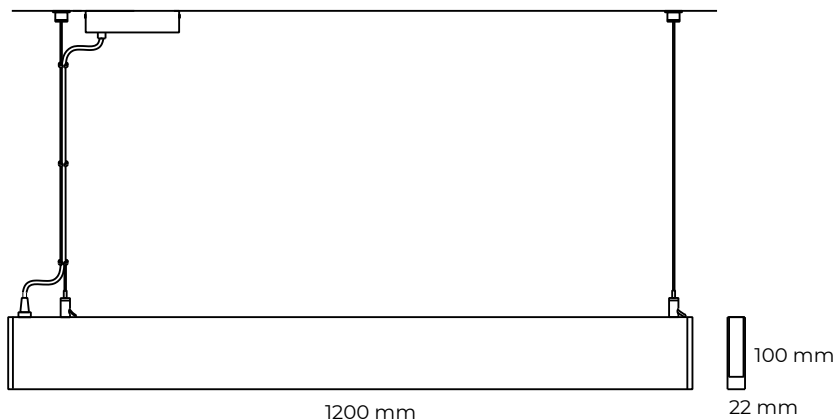

1. Voorzorgsmaatregelen en aanvullende informatie

- ① De verlichting moet qua specificaties overeenkomen met de driver (Inputvoltage AC220-240V 50/60Hz).
- ② De verlichting moet geïnstalleerd worden door een professionele elektricien.
- ③ Test vóór installatie de verlichting zodat u zeker weet dat deze werkt. Wanneer u deze getest heeft dient u de stroom van de verlichting af te halen om een elektrische schok te voorkomen.
- ④ Volg alle installatiestappen (weergegeven aan de rechterkant) om de verlichting op te juiste manier te installeren. Nadat de installatie is voltooid kunt u weer stroom op de verlichting zetten en deze aanzetten.
- ⑤ De IP-waarde van deze hanglamp is IP20. Deze is dus niet bestand tegen nevel en water. Deze hanglamp mag daarom alleen gebruikt worden binnenshuis in een droge en geventileerde ruimte.
- ⑥ Wanneer u de buitenkant van de hanglamp wilt schoonmaken doe dit dan alleen met een vochtige doek. De binnenkant van de hanglamp mag alleen met een droge doek afgestoft worden. Raak hierbij de LED verlichting zelf NIET aan!

2. Inhoud

- ① Hanglamp

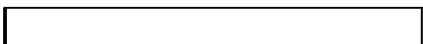

- ② Driver

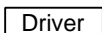

Driverbox met 1.5 m bedrading: 1 PC



Cilinders t.b.v. ophanging: 2 PCS



- ⑤ Fadenheftmaschine: 2 PCS



- ⑥ Plastic plugs: 3 PCS



- ⑦ Schroeven: 3 PCS



- ⑧ Draadklemmetjes: 3 PCS



- ⑨ Stalen draad (1500 mm): 2 PCS



3. Installatie instructies

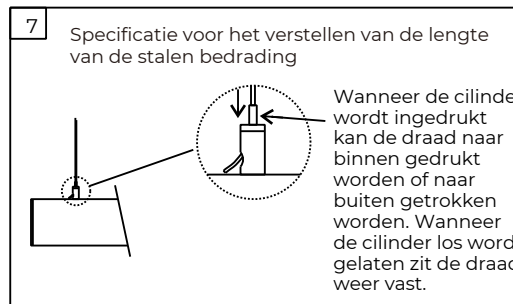
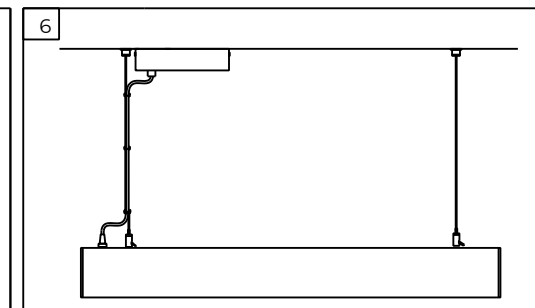
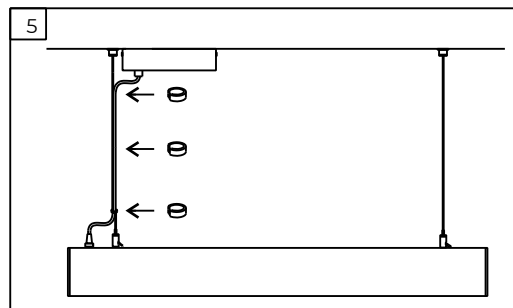
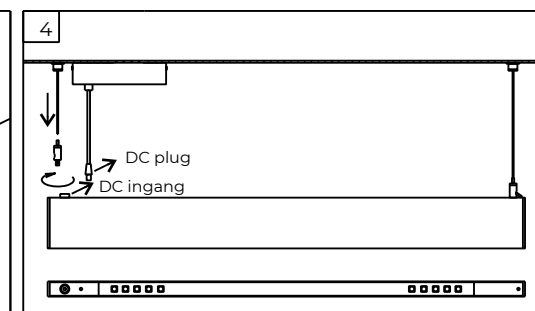
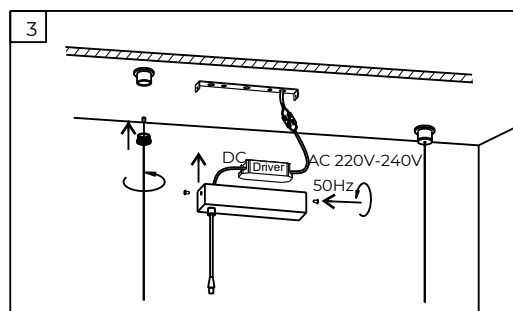
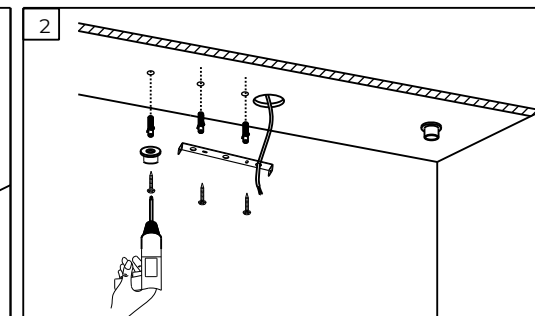
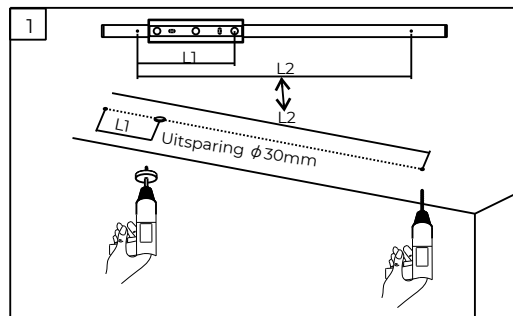

CE RoHS

B DUTCH

B DUTCH Linear Light Slim Matt White (BD11.0900001) / Matt Black (BD11.0900003) - 1200 mm - Opbouw INSTALLATION GUIDE

ENG
Voor NL
Z.O.Z.

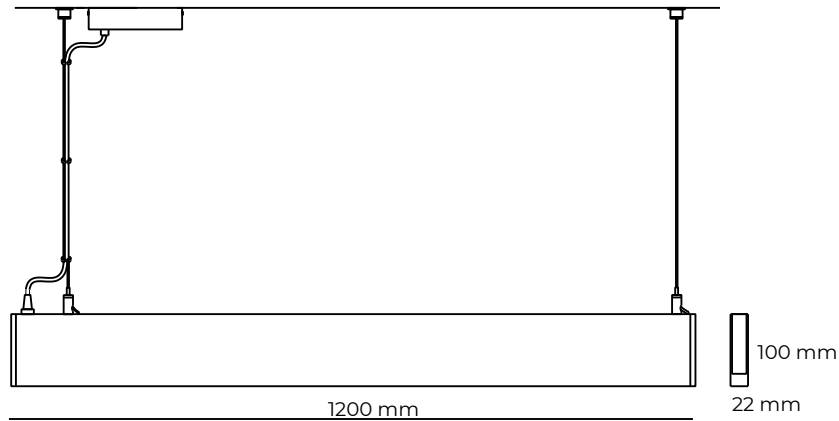

1. Precautions and further information

- ① The lights need to match the drivers (input voltage AC220-240V 50/60Hz).
- ② The lights must be installed by a professional electrician.
- ③ Before installing, try to turn on the lights to make sure they work, then please ensure to disconnect power supply to prevent an electric shock.
- ④ Please follow the installation instructions to install the lights. After the installation is completed, power it up again and try to turn on the lights.
- ⑤ The waterproof rate of the lights is IP20, which cannot be waterproof and fog-proof, please use it in a dry and ventilated indoor environment.
- ⑥ When cleaning the lights, it is recommended to use water, alcohol or no corrosive detergent to wipe the surface of lights.

2. Packing List

- ① LED Linear Light



- ② Driver

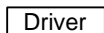

Driverbox with 1.5 m plug wire: 1 PC



Suction cylinder assembly: 2 PCS



- ⑤ Fadenheftmaschine: 2 PCS



- ⑥ Plastic plugs: 3 PCS



- ⑦ Screws: 3 PCS



- ⑧ Wire Clips: 3 PCS



- ⑨ Steel wires (1500 mm): 2 PCS



3. Installation Instructions

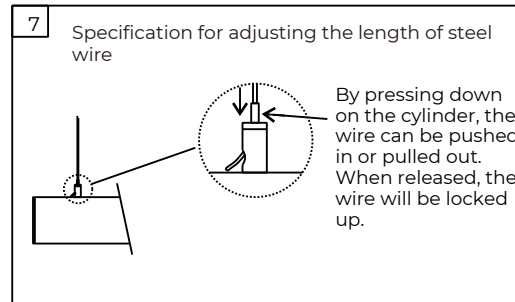
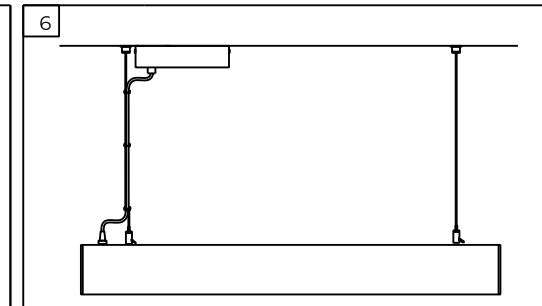
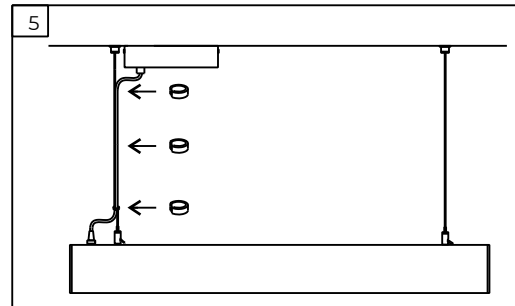
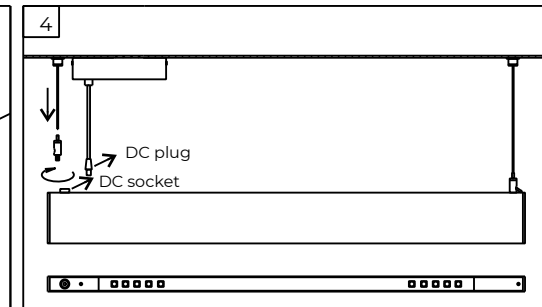
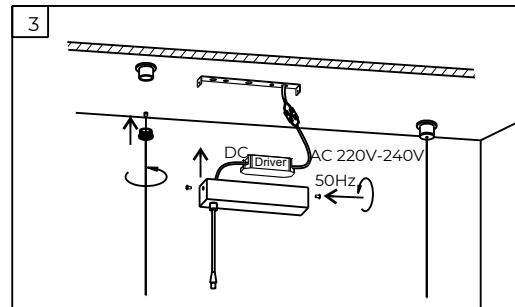
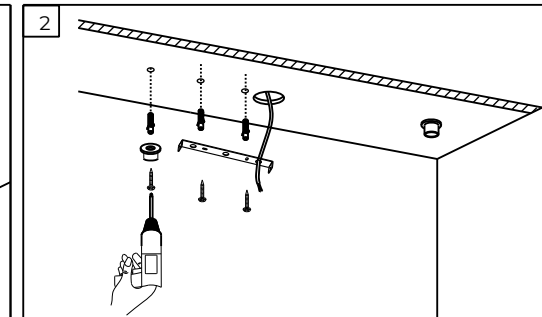
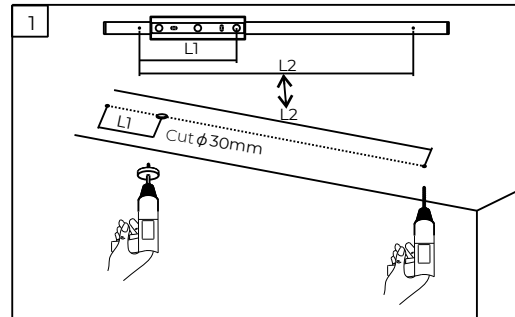

CE RoHS

B DUTCH